

CÔNG TY CP THƯƠNG MẠI VÀ CƠ KHÍ CNC VIỆT NAM

CNC
VIỆT NAM

THANG MÁNG CÁP TỬ ĐIỆN - TỬ CỨU HOẢ

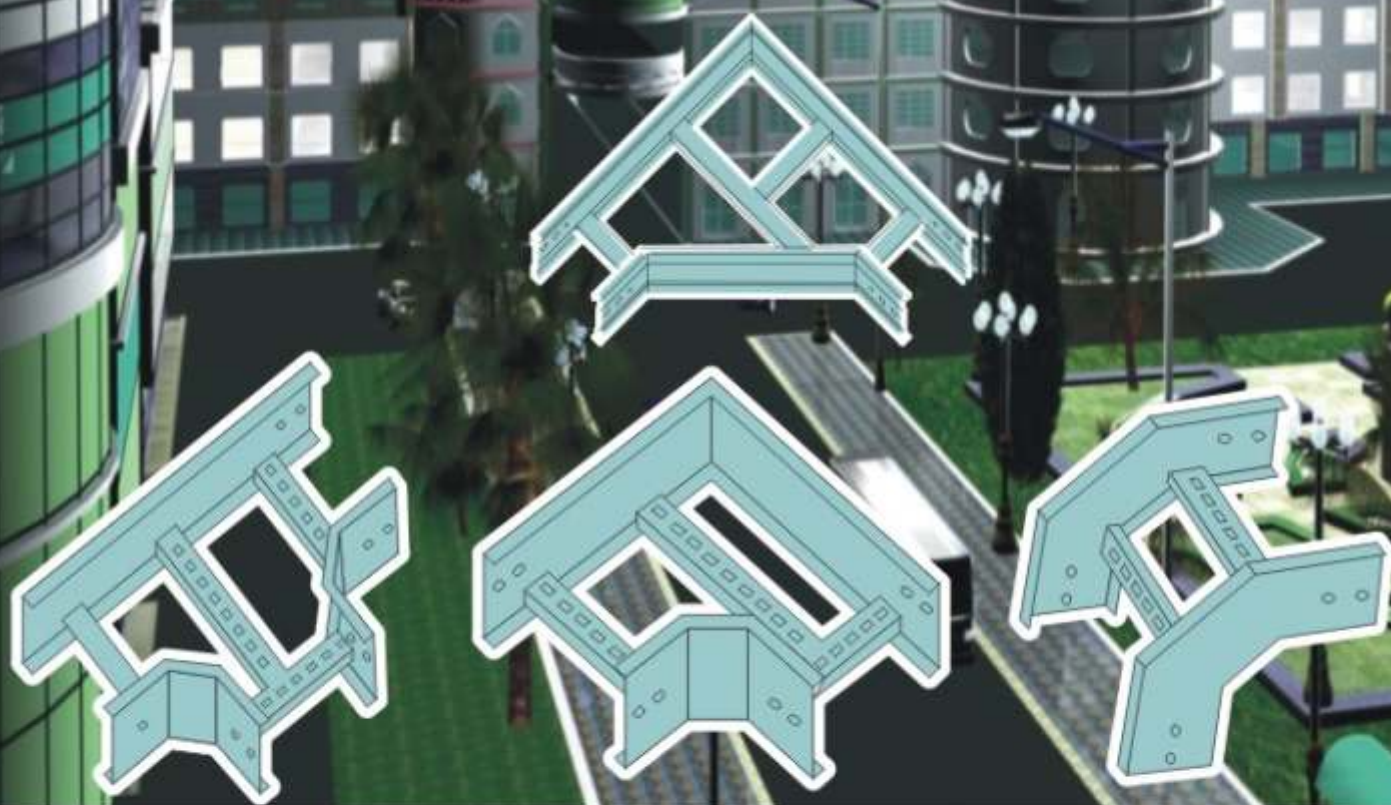

Add: Km 15 - Quốc lộ 1A - Yên Phú - Liên Ninh - Thanh Trì - Hà Nội

Tel: (84-4) 36865892 - Fax: (84-4) 36875791 * Email: cokhicnc@gmail.com - Website: cokhicnc.vn

HÌNH THỨC SẢN PHẨM

MẠ KÈM NHÙNG NÓNG

Bề mặt sản phẩm mạ kẽm nhúng nóng, sử dụng khi lắp đặt ngoài trời hoặc trong môi trường có độ ẩm cao.

SƠN TĨNH ĐIỆN

Bề mặt sản phẩm phủ bằng sơn tĩnh điện. Sử dụng lắp đặt trong nhà. Màu sắc tùy theo yêu cầu của khách hàng. Hai màu tiêu chuẩn là ghi xám (mã số: 7035) và trắng ngà vàng (mã số: 7032)

KÍCH THƯỚC

Thang máng cáp CNC được sản xuất với độ rộng tiêu chuẩn từ 500mm đến 800mm, độ dài 2500mm với đầy đủ các loại phụ kiện dùng cho lắp đặt. Trường hợp quý khách có yêu cầu đặc biệt xin vui lòng gửi cho chúng tôi đơn hàng kèm theo bản vẽ thiết kế chi tiết. Công ty chúng tôi sẽ đáp ứng các yêu cầu của Quý khách trong thời gian sớm nhất.

GUIDELIN FOR SELECTION

HOT-DIPPED GALVANIZED

Finished product appearance¹. Hot-dipped galvanized is use outside or humidity environment.

ELECTRO STATIC POWDER COATING

Electro static powder coating is used indoor only.

Color are available by customer's request.

Two standard color are light-gray (code: 7035) and yellow-white (code: 7032)

DIMENTION

Standard ladder and tray of CNC are from 50mm to 800mm in width and 2500mm in length. Each of CNC code include a full range of standard accessories. If customer have extra requirement please send us your detail request with drawing. We shall reponse your need in soonest time.

MODEL NOMENCLATURE / QUY TẮC ĐẶT TÊN SẢN PHẨM

CNC - L200x100



Height of Cable Ladder/Tray in mm unit

Width of Cable Ladder/Tray in mm unit

Type of Product

- L : Cable Ladder
 - LE : Cable Ladder Elbow
 - LT : Cable Ladder Tee connection
 - LX : Cable Ladder Horizontal Cross connection
 - LI : Cable Ladder Vertical Inside 90° Riser
 - LO : Cable Ladder Vertical Outside 90° Riser
 - T : Cable Tray
 - TE : Cable Tray Elbow
 - TT : Cable Tray Tee connection
 - TX : Cable Tray Horizontal Cross connection
 - TI : Cable Tray Vertical Inside 90° Riser
 - TO : Cable Tray Vertical Outside 90° Riser
 - C : Cover for Cable Ladder Tray
 - Ce : Cover for Cable Ladder Tray Elbow
 - CT : Cover for Cable Ladder Tray Tee connection
 - CX : Cover for Cable Ladder Tray Horizontal Cross connection
 - CI : Cover for Cable Ladder Tray Vertical Inside 90° Riser
 - CO : Cover for Cable Ladder Tray Vertical Outside 90° Riser
- CNC Manufacturer

CNC - L200x100



Chiều cao Thang/Máng cáp ở đơn vị mm

Chiều rộng Thang/Máng cáp ở đơn vị mm

Loại sản phẩm

- L : Thang cáp
 - LE : Chuyển góc 90° Thang
 - LT : Nối Thang chữ T
 - LX : Nối Thang chữ thập
 - LI : Nối Thang chuyển cấp 90° trong
 - LO : Nối Thang chuyển cấp 90° ngoài
 - T : Máng cáp
 - TE : Chuyển góc 90° Máng
 - TT : Nối Máng chữ T
 - TX : Nối Máng chữ thập
 - TI : Nối Máng chuyển cấp 90° trong
 - TO : Nối Máng chuyển cấp 90° ngoài
 - C : Nắp Thang/Máng cáp
 - Ce : Nắp Chuyển góc 90° Thang/Máng
 - CT : Nắp nối Thang/Máng chữ T
 - CX : Nắp nối Thang/Máng chữ thập
 - CI : Nắp nối Thang/Máng chuyển cấp 90° trong
 - CO : Nắp nối Thang/Máng chuyển cấp 90° ngoài
- Nhà sản xuất CNC



MÁNG CÁP
CABLE TRAY

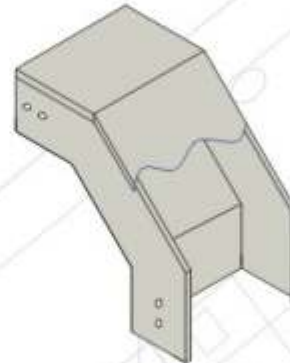

CƠ XƯƠNG MÁNG CÁP
CABLE TRAY V/ELBOW

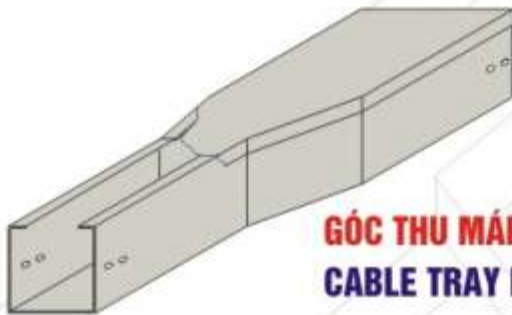

GÓC THU MÁNG CÁP
CABLE TRAY REDUCER

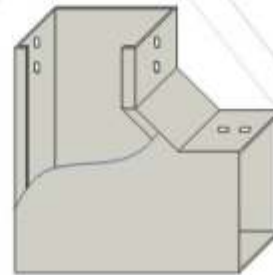

GÓC L MÁNG CÁP
CABLE TRAY H/ELBOW

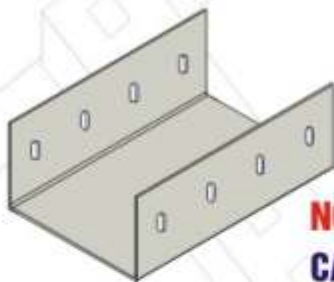

NỐI THẲNG MÁNG CÁP
CABLE TRAY CONNECTOR

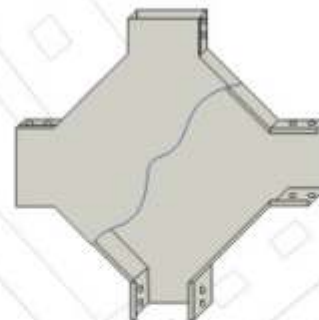

GÓC X MÁNG CÁP
CABLE TRAY CROSS

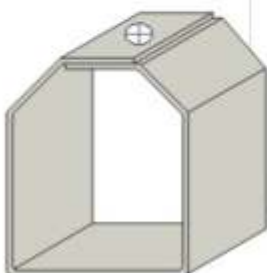

TREO MÁNG CÁP
CABLE TRAY HANG

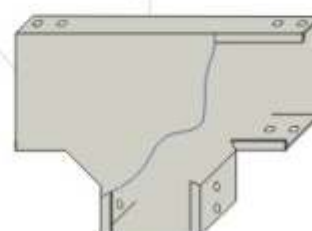

GÓC T MÁNG CÁP
CABLE TRAY TEE



THANG CÁP
CABLE LADDER



GÓC L THANG CÁP
CABLE LADDER H/ELBOW

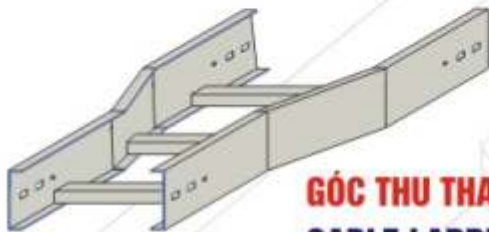

GÓC THU THANG CÁP
CABLE LADDER REDUCER

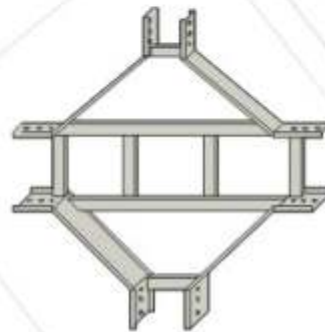

GÓC X THANG CÁP
CABLE LADDER CROSS



CƠ XƯỚNG THANG CÁP
CABLE LADDER V/ELBOW

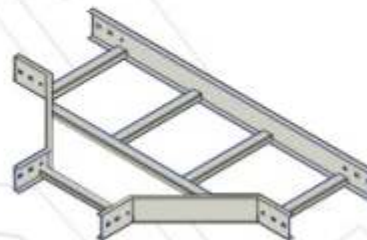

GÓC T THANG CÁP
CABLE LADDER TEE

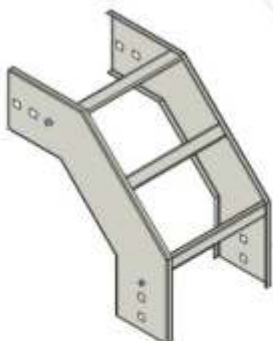

CƠ LÊN THANG CÁP
CABLE LADDER V/ELBOW

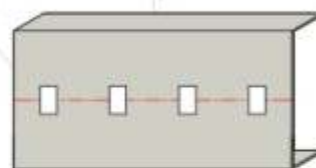

NỐI THẲNG THANG CÁP
CONNECTOR

MÁNG CÁP CABLE TRAY

I: TL 3-1

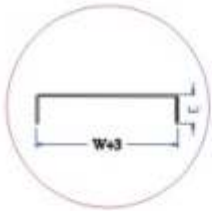

III: TL 3-1

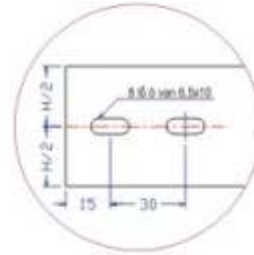

II: TL 3-1

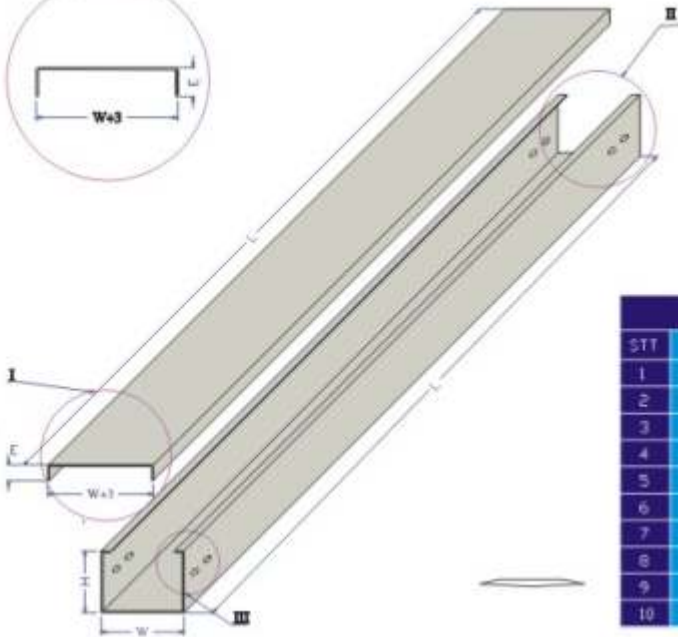
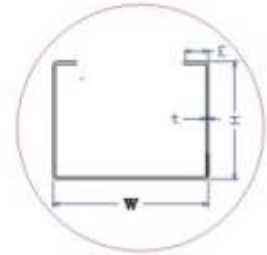

Dimension/mm - Weight/kg									
STT	w	L	H	E	t	a	b	Weight/kg	Note
1	100	2500	100	20	2.0				Kg
2	200	2500	100	20	2.0				Kg
3	300	2500	100	20	2.0				Kg
4	400	2500	100	20	2.0				Kg
5	500	2500	100	20	2.0				Kg
6	600	2500	100	20	2.0				Kg
7	700	2500	100	20	2.0				Kg
8	800	2500	100	20	2.0				Kg
9	900	2500	100	20	2.0				Kg
10	1000	2500	100	20	2.0				Kg

GÓC THU MÁNG CÁP CABLE TRAY REDUCER

III: TL 3-1

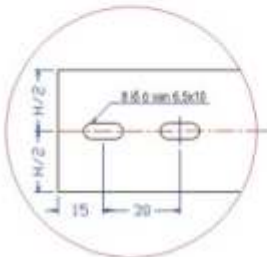

II: TL 2-1

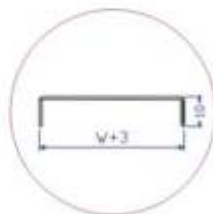

I: TL 2-1

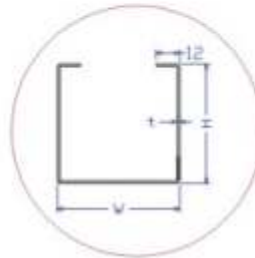

Thu W1/W2/Hxt												
STT	W1	W2								Note		
1	50	100	150	200	250	300	350	400	450	500	L	270
2	100	150	200	250	300	350	400	450	500		H	100
3	150	200	250	300	350	400	450	500			E	20
4	200	250	300	350	400	450	500				t	2.0
5	250	300	350	400	450	500					a	100
6	300	350	400	450	500						b	70
7	350	400	450	500								
8	400	450	500									
9	450	500										
10	500											

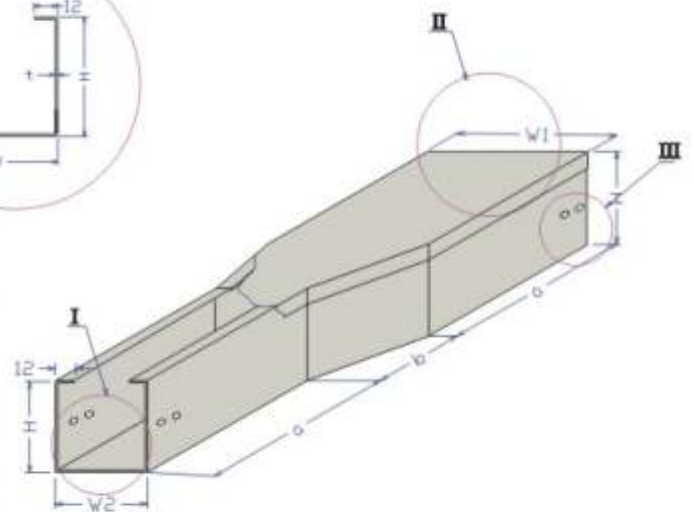

NỐI THẲNG MÁNG CÁP
CABLE TRAY CONNECTOR

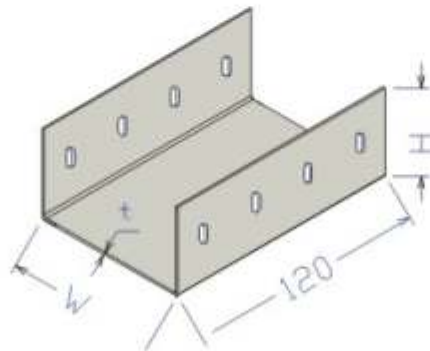
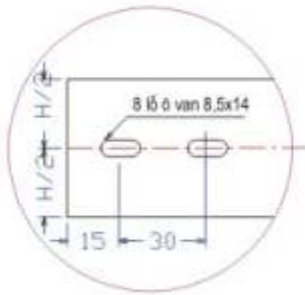

NỐI THẲNG MÁNG CÁP

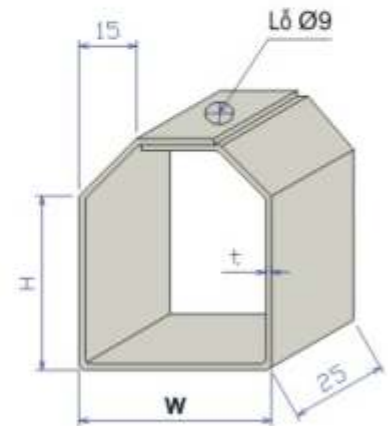

TREO MÁNG CÁP

CO XƯỚNG MÁNG CÁP
CABLE TRAY V/ELBOW

I: TL 2-1



II: TL 1-1

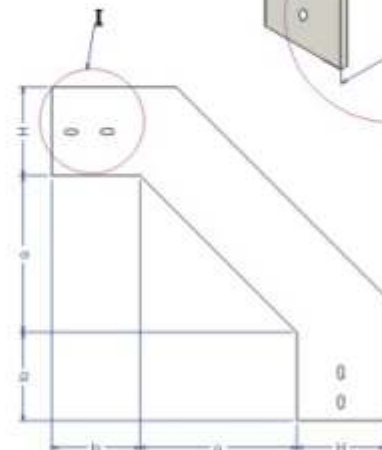
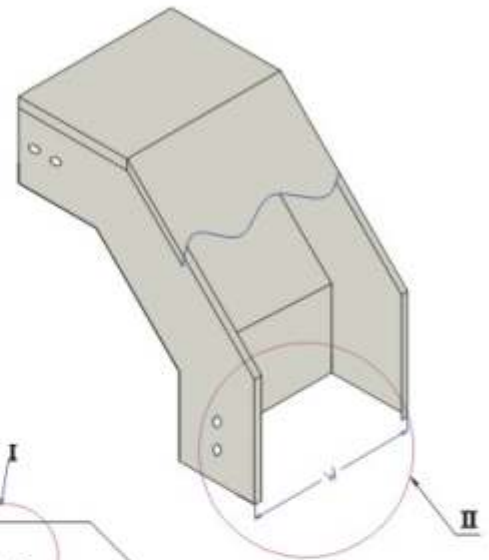
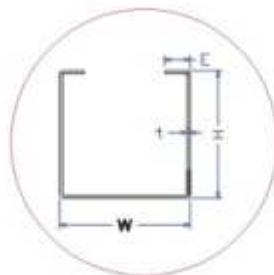

ST	W	H	E	t	ø	b	Weight/kg	Note
1	150	100	20	1.2	70	100	Kg	
2	200	100	20	1.2	70	100		
3	250	100	20	1.2	70	100		
4	300	100	20	1.2	70	100		
5	350	100	20	1.2	70	100		
6	400	100	20	1.2	70	100		
7	450	100	20	1.2	70	100		
8	500	100	20	1.2	70	100		
9	550	100	20	1.2	70	100		
10	600	100	20	1.2	70	100		

GÓC L MÁNG CÁP CABLE TRAY H/ELBOW

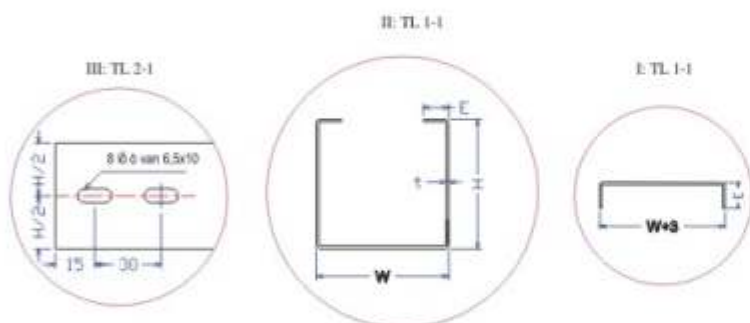

STT	V	H	E	t	a	b	Weight/kg	Note
1	150	100	20	1.2	70	100		Kg
2	200	100	20	1.2	70	100		
3	250	100	20	1.2	70	100		
4	300	100	20	1.2	70	100		
5	350	100	20	1.2	70	100		
6	400	100	20	1.2	70	100		
7	450	100	20	1.2	70	100		
8	500	100	20	1.2	70	100		
9	550	100	20	1.2	70	100		
10	600	100	20	1.2	70	100		

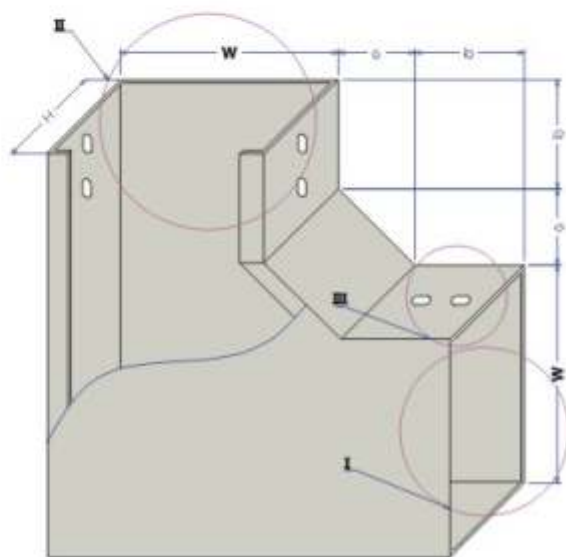

GÓC X MÁNG CÁP CABLE TRAY CROSS

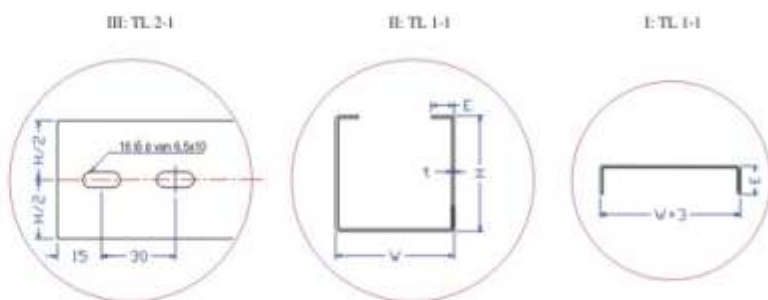
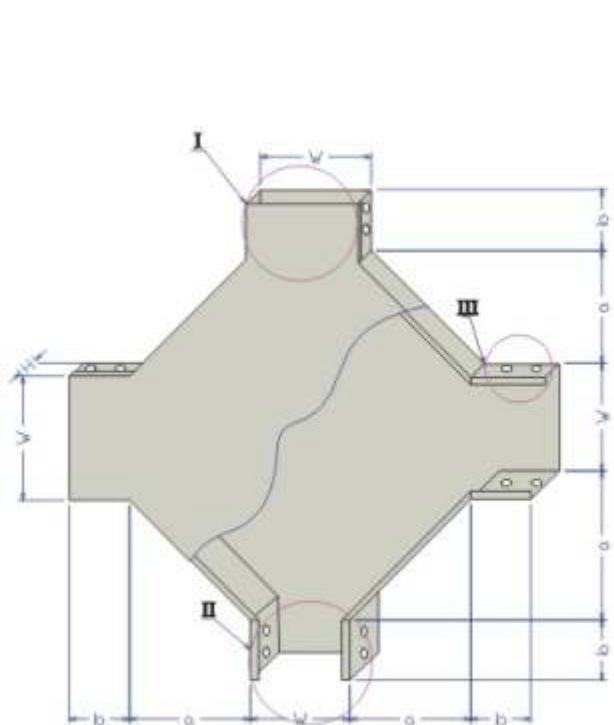

STT	V	H	E	t	a	b	Weight/kg	Note
1	150	100	20	1.2	70	100		Kg
2	200	100	20	1.2	70	100		
3	250	100	20	1.2	70	100		
4	300	100	20	1.2	70	100		
5	350	100	20	1.2	70	100		
6	400	100	20	1.2	70	100		
7	450	100	20	1.2	70	100		
8	500	100	20	1.2	70	100		
9	550	100	20	1.2	70	100		
10	600	100	20	1.2	70	100		

GÓC T MÀNG CÁP CABLE TRAY TEE

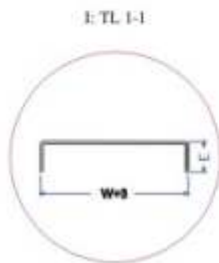
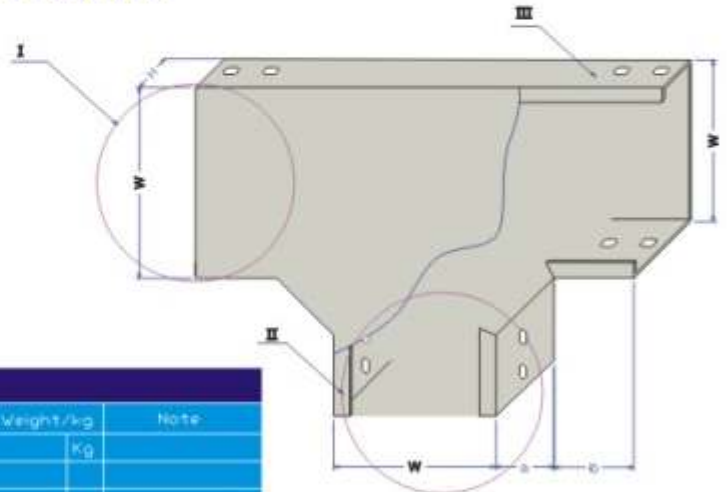
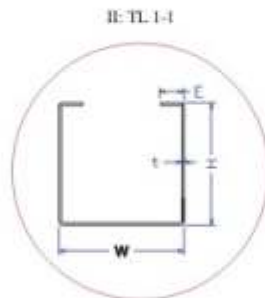
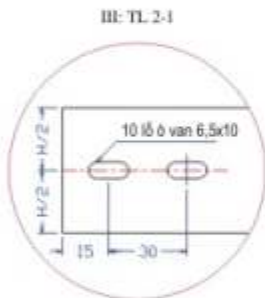

STT	W	H	E	t	a	b	Weight/kg	Note
1	150	100	20	1,2	70	100		
2	200	100	20	1,2	70	100		
3	250	100	20	1,2	70	100		
4	300	100	20	1,2	70	100		
5	350	100	20	1,2	70	100		
6	400	100	20	1,2	70	100		
7	450	100	20	1,2	70	100		
8	500	100	20	1,2	70	100		
9	550	100	20	1,2	70	100		
10	600	100	20	1,2	70	100		

THANG CÁP CABLE LADDER

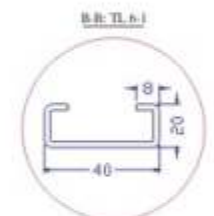
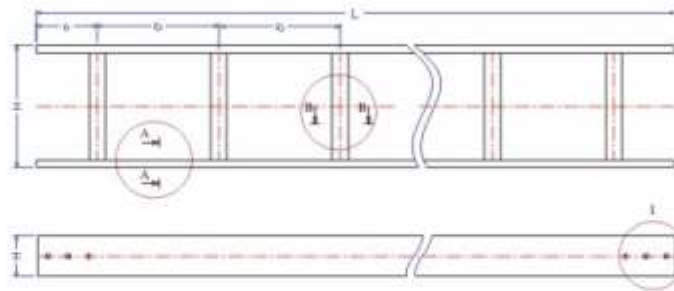

STT	W	L	H	E	t	a	b	Weight/kg	Note
1	100	2500	100	20	2,0	139	278		
2	200	2500	100	20	2,0	139	278		
3	300	2500	100	20	2,0	139	278		
4	400	2500	100	20	2,0	139	278		
5	500	2500	100	20	2,0	139	278		
6	600	2500	100	20	2,0	139	278		
7	700	2500	100	20	2,0	139	278		
8	800	2500	100	20	2,0	139	278		
9	900	2500	100	20	2,0	139	278		
10	1000	2500	100	20	2,0	139	278		

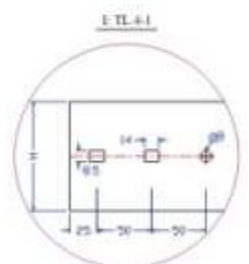



GÓC THU THANG CẤP
CABLE LADDER REDUCER

I-TL 4-1

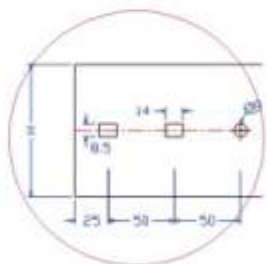

A-A: TL 5-1

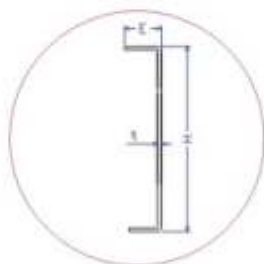

B-B: TL 6-1

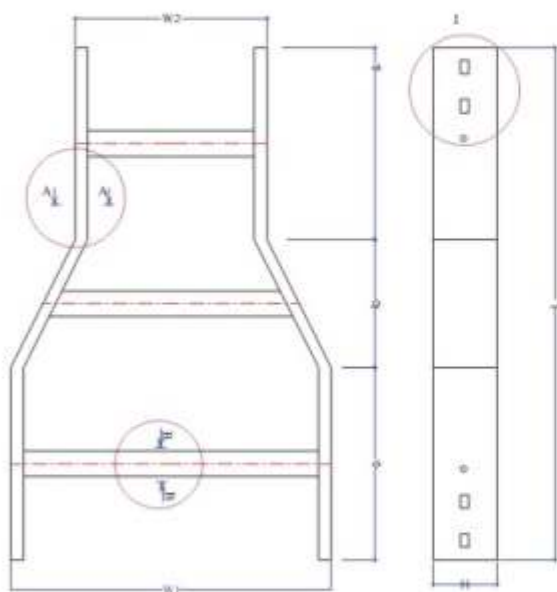
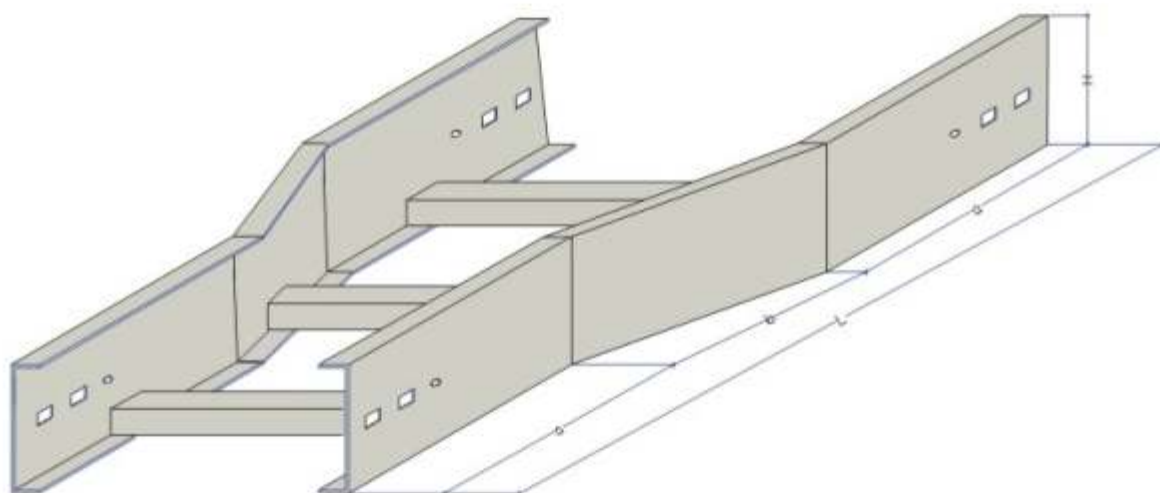
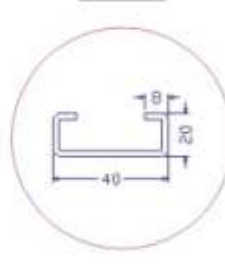

STT	Thu w1/w2/Hxt										Note	
	w1	w2										
1	300	400	500	600	700	800	900	1000	1100	1200	L	800
2	400	500	600	700	800	900	1000	1100	1200		H	100
3	500	600	700	800	900	1000	1100	1200			E	20
4	600	700	800	900	1000	1100	1200				t	2.5
5	700	800	900	1000	1100	1200					h	300
6	800	900	1000	1100	1200						k	200
7	900	1000	1100	1200								
8	1000	1100	1200									
9	1100	1200										
10	1200											

CO XƯỚNG THANG CÁP CABLE LADDER V/ELBOW

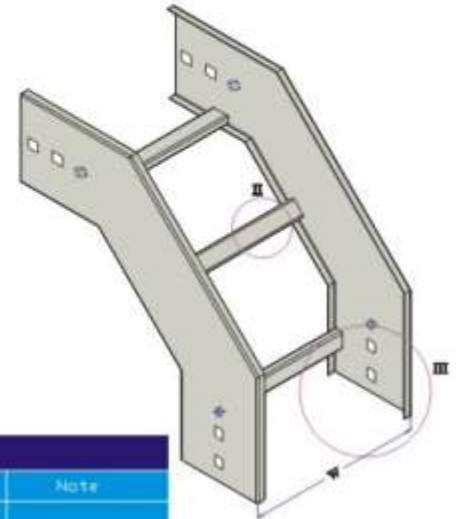
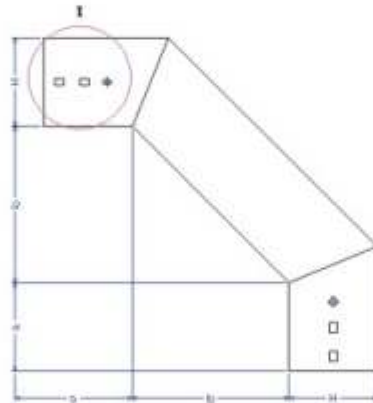
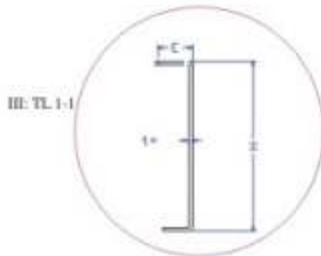
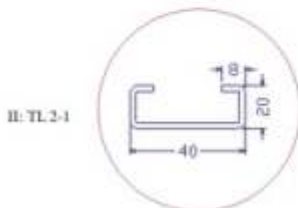
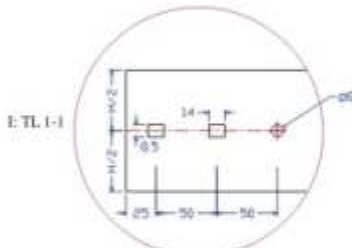

Dimension/mm - Weight/kg								
STT	w	H	C	t	a	b	Weight/kg	Note
1	300	100	20	2.0	150	300	26.00	Kg
2	400	100	20	2.0	150	300	Kg	
3	500	100	20	2.0	150	300	Kg	
4	600	100	20	2.0	150	300	Kg	
5	700	100	20	2.0	150	300	Kg	
6	800	100	20	2.0	150	300	Kg	
7	900	100	20	2.0	150	300	Kg	
8	1000	100	20	2.0	150	300	Kg	
9	1100	100	20	2.0	150	300	Kg	
10	1200	100	20	2.0	150	300	Kg	

CO LÊN THANG CÁP CABLE LADDER V/ELBOW

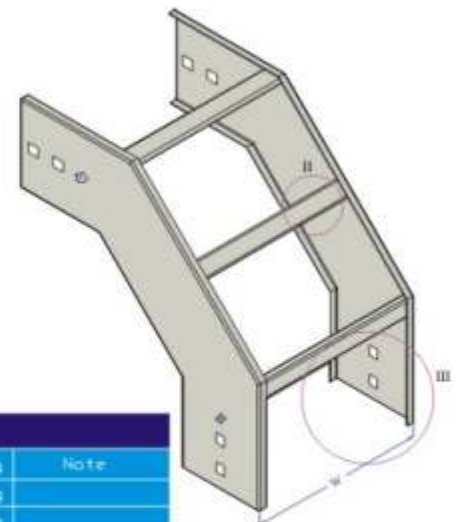
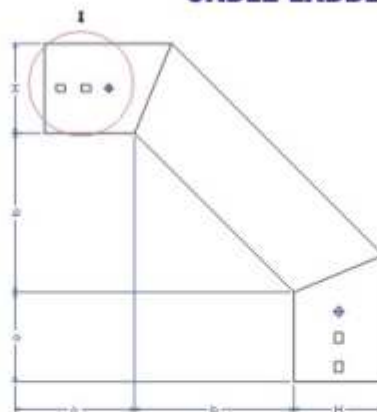
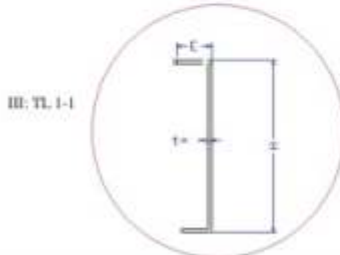
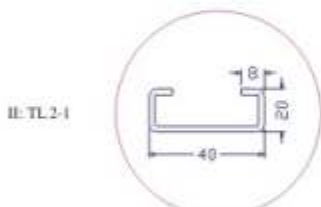
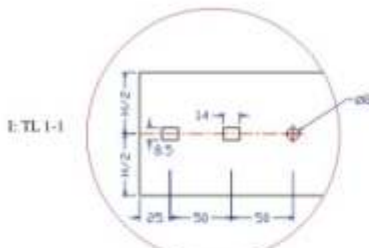

Dimension/mm - Weight/kg								
STT	w	H	C	t	a	b	Weight/kg	Note
1	300	100	20	2.0	150	300	26.00	Kg
2	400	100	20	2.0	150	300	Kg	
3	500	100	20	2.0	150	300	Kg	
4	600	100	20	2.0	150	300	Kg	
5	700	100	20	2.0	150	300	Kg	
6	800	100	20	2.0	150	300	Kg	
7	900	100	20	2.0	150	300	Kg	
8	1000	100	20	2.0	150	300	Kg	
9	1100	100	20	2.0	150	300	Kg	
10	1200	100	20	2.0	150	300	Kg	

GÓC L THANG CÁP CABLE LADDER H/ELBOW

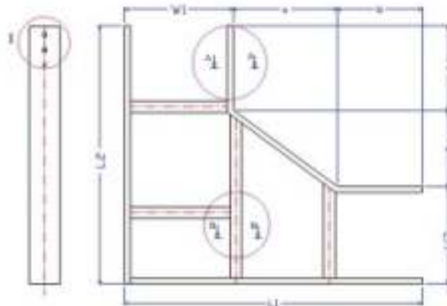
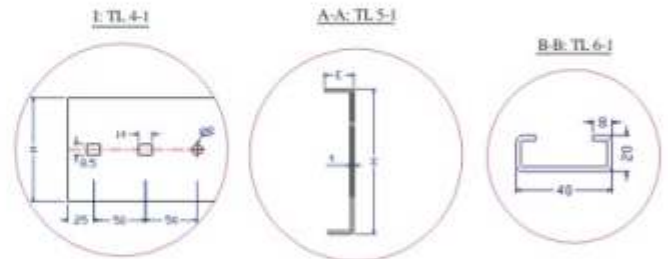
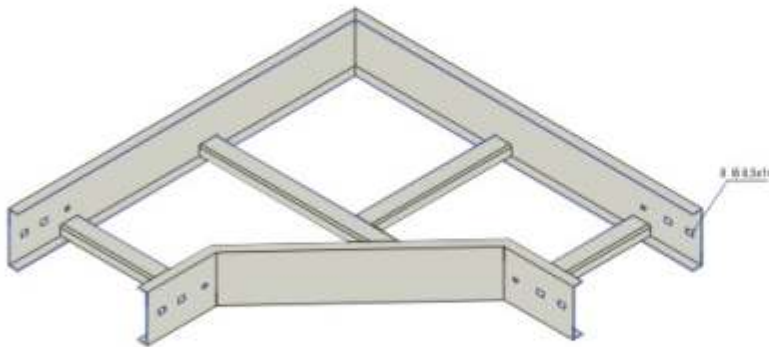

Dimension/mm - Weight/kg											
STT	W1	W2	L1	L2	H	E	t	a	b	Weight/kg	Note
1	300	400	750	950	100	20	2.0	150	300	26.00	Kg
2	400	500	850	950	100	20	2.0	150	300		Kg
3	500	600	950	1050	100	20	2.0	150	300		Kg
4	600	700	1050	1150	100	20	2.0	150	300		Kg
5	700	800	1150	1250	100	20	2.0	150	300		Kg
6	800	900	1250	1350	100	20	2.0	150	300		Kg
7	900	1000	1350	1450	100	20	2.0	150	300		Kg
8	1000	1100	1450	1550	100	20	2.0	150	300		Kg
9	1100	1200	1550	1650	100	20	2.0	150	300		Kg
10	1200	1200	1650	1650	100	20	2.0	150	300		Kg

GÓC X THANG CÁP CABLE LADDER CROSS

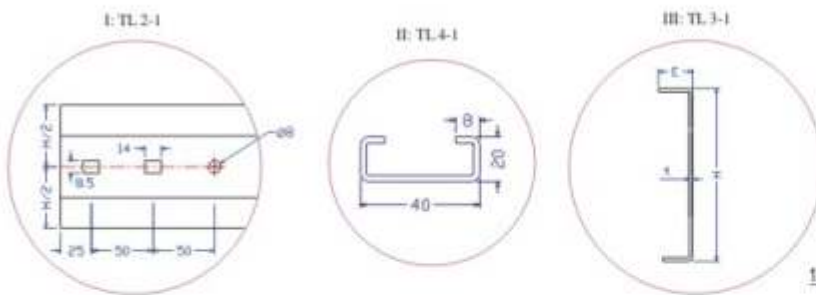

Dimension/mm - Weight/kg									
STT	V	H	E	t	b	a	Weight/kg	Note	
1	300	100	20	2.0	150	300	26.00	Kg	
2	400	100	20	2.0	150	300		Kg	
3	500	100	20	2.0	150	300		Kg	
4	600	100	20	2.0	150	300		Kg	
5	700	100	20	2.0	150	300		Kg	
6	800	100	20	2.0	150	300		Kg	
7	900	100	20	2.0	150	300		Kg	
8	1000	100	20	2.0	150	300		Kg	
9	1100	100	20	2.0	150	300		Kg	
10	1200	100	20	2.0	150	300		Kg	

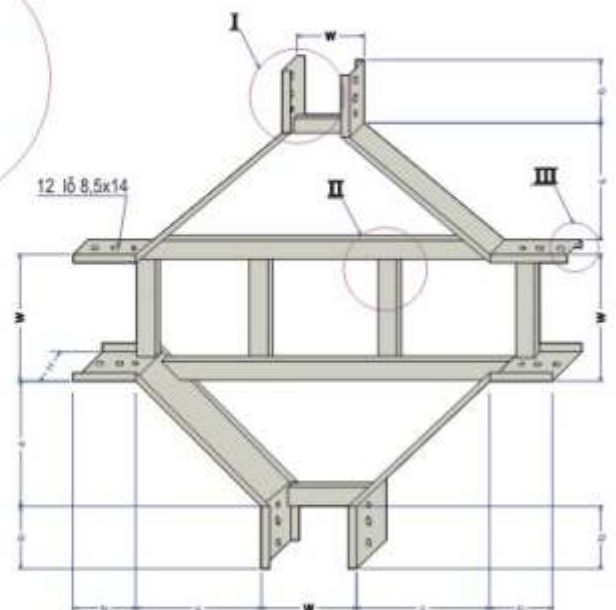

GÓC T THANG CÁP CABLE LADDER TEE

B-B: TL 6-1

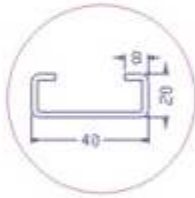

A-A: TL 5-1

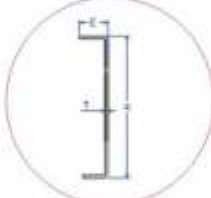

I: TL 4-1

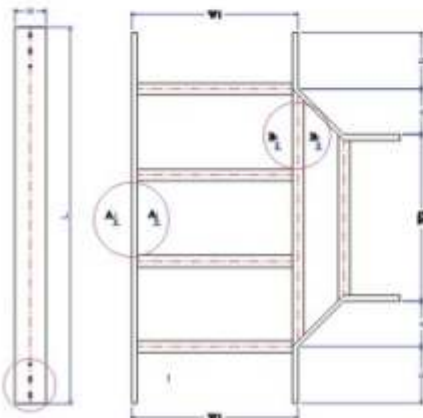
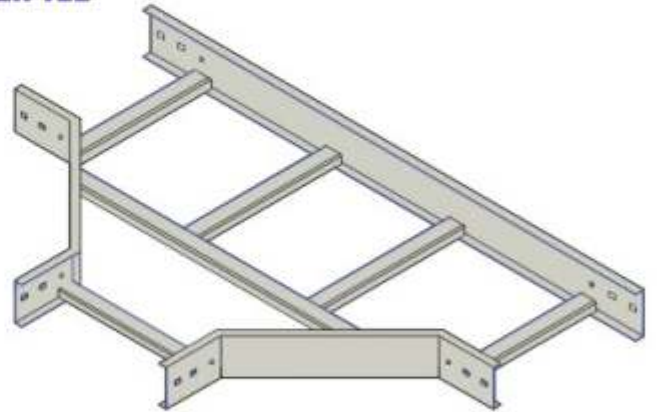
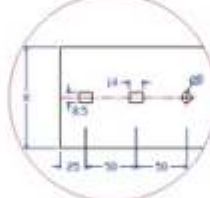

Dimension/mm - Weight/kg										
STT	W	V2	L	H	E	t	a	b	Weight/kg	Note
1	300	400	1300	100	28	2.0	150	300	25.00	Kg
2	400	500	1400	100	28	2.0	150	300	Kg	
3	500	600	1500	100	28	2.0	150	300	Kg	
4	600	700	1600	100	28	2.0	150	300	Kg	
5	700	800	1700	100	28	2.0	150	300	Kg	
6	800	900	1800	100	28	2.0	150	300	Kg	
7	900	1000	1900	100	28	2.0	150	300	Kg	
8	1000	1100	2000	100	28	2.0	150	300	Kg	
9	1100	1200	2100	100	28	2.0	150	300	Kg	
10	1200	1300	2200	100	28	2.0	150	300	Kg	

NỐI THẰNG THANG CÁP CONNECTOR

NỐI THẰNG THANG CÁP

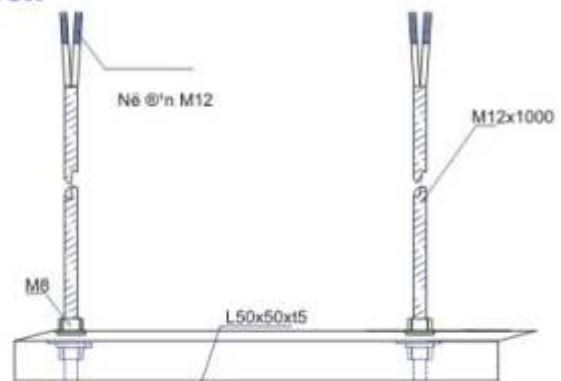
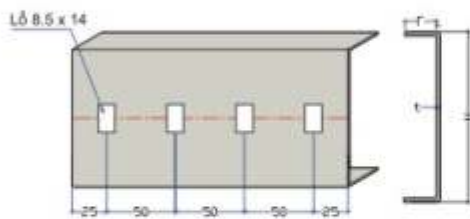

KHUNG ĐỖ THANG, MĂNG CÁP L50X50X4

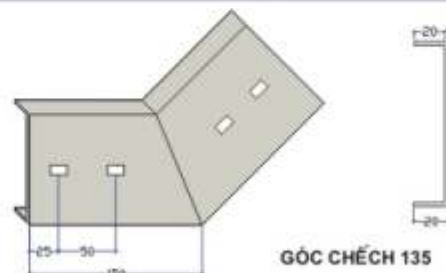
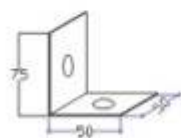

GÓC CHÉCH 135

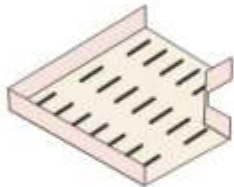

NỐI CHỮ L
90° HORIZONTAL ELBOW



TỦ DỰNG BÌNH CỨU HOẢ
DRY CHEMICAL FIRE EXTINGUISHER STORAGE BOX

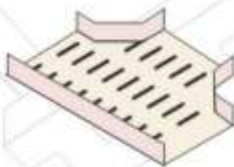

NỐI CHỮ T
TEE CONNECTION



TỦ ĐIỀU KHIỂN
CONTROL PANEL



NỐI CHỮ THẬP
CROSS CONNECTION



TỦ PHÂN PHỐI
POWER PANEL

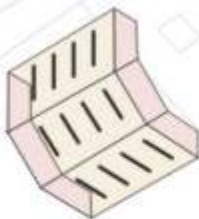

CHUYỂN CẤP 90° LÊN
90° VERTICAL INSIDE RISER



TỦ BIẾN TẦN
INVERTER CABINET

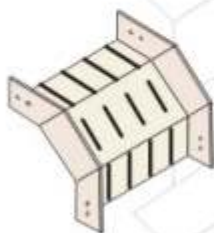

CHUYỂN CẤP 90° XUỐNG
90° VERTICAL OUTSIDE RISER



TỦ DỰNG ĐA NĂNG
ANTI-DISTURBANCE GOODS STORAGE CABINET

TỦ ĐIỆN THÔNG DỤNG

- PDT0** - Loại 300 (cao) x 200 (rộng) x 150mm (sâu)
Matal Enclosure 300 (H) x 200 (W) x 150mm (D)
- PDT1** - Loại 350 (cao) x 250 (rộng) x 150mm (sâu)
Matal Enclosure 350 (H) x 250 (W) x 150mm (D)
- PDT2** - Loại 450 (cao) x 300 (rộng) x 170mm (sâu)
Matal Enclosure 450 (H) x 300 (W) x 170mm (D)
- PDT3** - Loại 520 (cao) x 320 (rộng) x 170mm (sâu)
Matal Enclosure 520 (H) x 320 (W) x 170mm (D)
- PDT4** - Loại 570 (cao) x 400 (rộng) x 200mm (sâu)
Matal Enclosure 570 (H) x 400 (W) x 200mm (D)
- PDT5** - Loại 610 (cao) x 440 (rộng) x 230mm (sâu)
Matal Enclosure 610 (H) x 440 (W) x 230mm (D)
- PDT6** - Loại 690 (cao) x 570 (rộng) x 250mm (sâu)
Matal Enclosure 690 (H) x 570 (W) x 250mm (D)
- PDT7** - Loại 760 (cao) x 600 (rộng) x 250mm (sâu)
Matal Enclosure 760 (H) x 600 (W) x 250mm (D)
- PDT8** - Loại 920 (cao) x 690 (rộng) x 250mm (sâu)
Matal Enclosure 920 (H) x 690 (W) x 250mm (D)
- PDT9** - Loại 800 (cao) x 800 (rộng) x 250mm (sâu)
Matal Enclosure 800 (H) x 500 (W) x 250mm (D)



TỦ ĐIỆN NGOÀI TRỜI



TỦ ĐIỆN NỘI



TỦ ĐỘNG HỒ SƠ



TỦ ĐIỀU KHIỂN - CONTROL PANEL



TỦ PHÂN PHỐI - POWER PANEL



CÔNG TY CP THƯƠNG MẠI VÀ CƠ KHÍ CNC VIỆT NAM

**THANG MĂNG CÁP
TỬ ĐIỆN - TỬ CỨU HOẢ**



Add: Km 15 - Quốc lộ 1A - Yên Phú - Liên Ninh - Thanh Trì - Hà Nội

Tel: (84-4) 36865892 - Fax: (84-4) 36875791 * Email: cokhicnc@gmail.com - Website: cokhicnc.vn